

## Quick Start Guide

Laser displacement sensor with both analog and discrete (switched) outputs

This guide is designed to help you set up and install the L-GAGE® LE Laser Gauging Sensor. For complete information on programming, performance, troubleshooting, dimensions, and accessories, please refer to the Instruction Manual at [www.bannerengineering.com](http://www.bannerengineering.com). Search for p/n 175094 to view the manual. Use of this document assumes familiarity with pertinent industry standards and practices.



### WARNING: Not To Be Used for Personnel Protection

Never use this device as a sensing device for personnel protection. Doing so could lead to serious injury or death. This device does not include the self-checking redundant circuitry necessary to allow its use in personnel safety applications. A sensor failure or malfunction can cause either an energized or de-energized sensor output condition.

## Features and Indicators

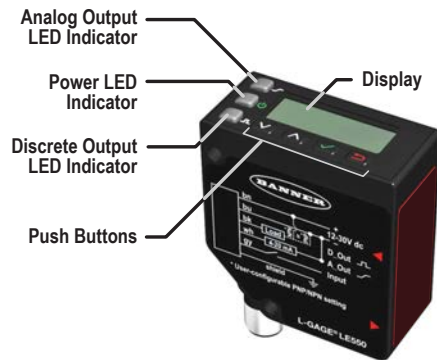

Figure 1. LE Analog Sensor Features

Three LED indicators provide ongoing indication of the sensing status.

### Analog Output LED Indicator

- Solid Amber = Displayed distance is within the taught analog output window
- Off = Displayed distance is outside the taught analog output window

### Power LED Indicator

- Solid Green = Normal operation, power On and laser On
- Flashing Green (1 Hz) = Power On and laser Off (laser enable mode)

### Discrete Output LED Indicator

- Solid Amber = Discrete Output is On
- Off = Discrete Output is Off

## Laser Description and Safety Information



CAUTION: Use of controls or adjustments or performance of procedures other than those specified herein may result in hazardous radiation exposure. Do not attempt to disassemble this sensor for repair. A defective unit must be returned to the manufacturer.

### Class 2 Laser Models



CAUTION: Never stare directly into the sensor lens. Laser light can damage your eyes. Avoid placing any mirror-like object in the beam. Never use a mirror as a retroreflective target.



### For Safe Laser Use - Class 2 Lasers

- Do not stare at the laser.
- Do not point the laser at a person's eye.
- Mount open laser beam paths either above or below eye level, where practical.
- Terminate the beam emitted by the laser product at the end of its useful path.

Reference IEC 60825-1:2007, Section 8.2.



Class 2 Lasers

Class 2 lasers are lasers that emit visible radiation in the wavelength range from 400 nm to 700 nm, where eye protection is normally afforded by aversion responses, including the blink reflex. This reaction may be expected to provide adequate protection under reasonably foreseeable conditions of operation, including the use of optical instruments for intrabeam viewing.

Class 2 Laser Safety Notes

Low-power lasers are, by definition, incapable of causing eye injury within the duration of a blink (aversion response) of 0.25 seconds. They also must emit only visible wavelengths (400 to 700 nm). Therefore, an ocular hazard may exist only if individuals overcome their natural aversion to bright light and stare directly into the laser beam.



Figure 2. FDA (CDRH) warning label (Class 2)

Class 1 Laser Models

Class 1 lasers are lasers that are safe under reasonably foreseeable conditions of operation, including the use of optical instruments for intrabeam viewing.

Laser wavelength: 650 nm      Output: < 0.22 mW      Pulse Duration: 150 µs to 900 µs



Figure 3. FDA (CDRH) warning label (Class 1)

Sensor Installation



NOTE: Handle the sensor with care during installation and operation. Sensor windows soiled by fingerprints, dust, water, oil, etc. may create stray light that may degrade the peak performance of the sensor. Blow the window clear using filtered, compressed air, then clean as necessary using 70% isopropyl alcohol and cotton swabs or water and a soft cloth.

Sensor Orientation

Correct sensor-to-object orientation is important to ensure proper sensing. See the following figures for examples of correct and incorrect sensor-to-object orientation as certain placements may pose problems for sensing distances.

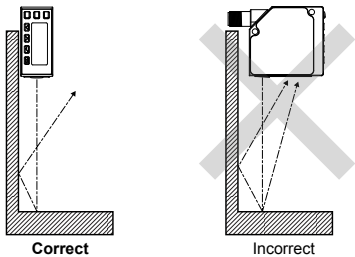

Figure 4. Orientation by a wall

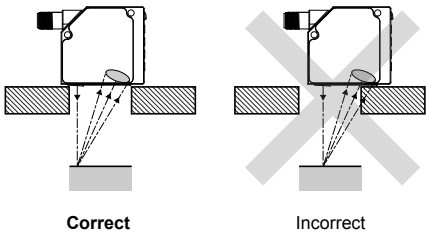

Figure 5. Orientation in an opening

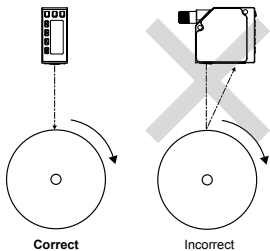

Figure 6. Orientation for a turning object

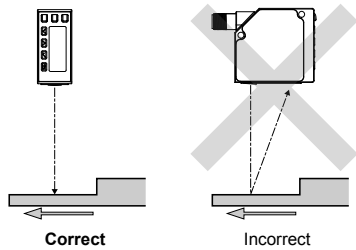

Figure 7. Orientation for a height difference

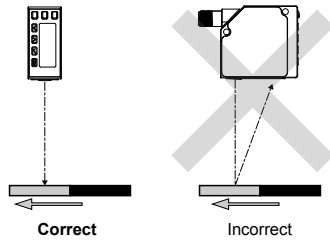

Figure 8. Orientation for a color or luster difference

## Sensor Mounting

1. If a bracket is needed, mount the sensor onto the bracket.
2. Mount the sensor (or the sensor and the bracket) to the machine or equipment at the desired location. Do not tighten at this time.
3. Check the sensor alignment.
4. Tighten the screws to secure the sensor (or the sensor and the bracket) in the aligned position.

## Wiring Diagrams

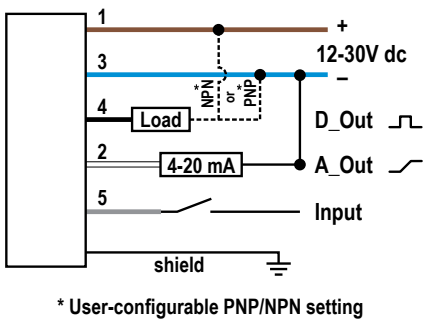

Figure 9. Analog Current Model

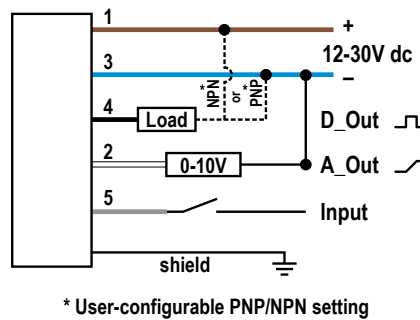
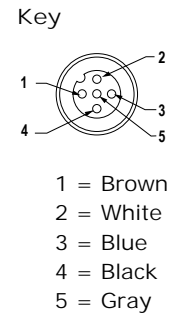

Figure 10. Analog Voltage Model



## Display



Figure 11. LE550 Display in Run Mode

The display is a 2-line, 8-character LCD. The main screen is the Run mode screen, which shows the real-time distance measurement and the analog output measurement.

## Buttons

Use the sensor buttons Down, Up, Enter, and Escape to program the sensor and to access sensor information.



Down and Up Buttons

Press Down and Up to:

- Access the Quick Menu from Run mode
- Navigate the menu systems
- Change programming settings

When navigating the menu systems, the menu items loop.

Press Down and Up to change setting values. Press and hold the buttons to cycle through numeric values. After changing a setting value, it slowly flashes until the change is saved using the Enter button.



Enter Button

Press Enter to:

- Access the Sensor Menu from Run mode
- Access the submenus
- Save changes

In the Sensor Menu, a check mark ✓ in the lower right corner of the display indicates that pressing Enter accesses a submenu.

Press Enter to save changes. New values flash rapidly and the sensor returns to the parent menu.



Escape Button

Press Escape to:

- Leave the current menu and return to the parent menu
- Return to Run mode from the Quick Menu



Important: Pressing Escape discards any unsaved programming changes.

In the Sensor Menu, a return arrow ↩ in the upper left corner of the display indicates that pressing Escape returns to the parent menu.

Press and hold Escape for 2 seconds to return to Run mode from any menu or remote teach.

## Sensor Programming

Program the sensor using the buttons on the sensor or the remote input (limited programming options).

From Run mode, use the buttons to access the Quick Menu and the Sensor Menu. See [Quick Menu](#) on page 5, [Sensor Menu \(MENU\)](#) on page 6, and the instruction manual (p/n 175094) for more information on the options available from each menu. For TEACH options, follow the TEACH instructions in the instruction manual.

In addition to programming the sensor, use the remote input to disable the buttons for security, preventing unauthorized or accidental programming changes. See the instruction manual for more information.

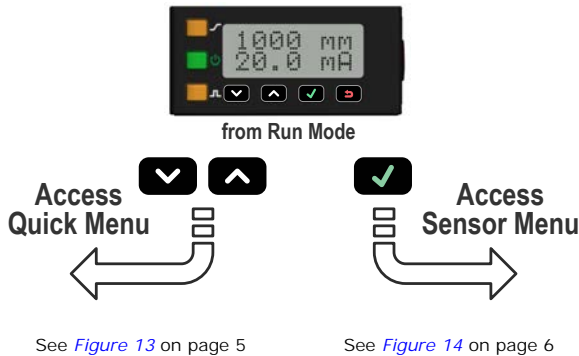







Figure 12. Accessing the LE Menus

## Quick Menu

The sensor includes a Quick Menu with easy access to view and change the analog and discrete output switch points.

Access the Quick Menu by pressing Down  or Up  from Run mode. When in the Quick Menu, the current distance measurement displays on the first line and the menu name and the analog value alternate on the second line of the display. Press Enter  to access the switch points. Press Down  or Up  to change the switch point to the desired value. Press Enter  to save the new value and return to the Quick Menu.

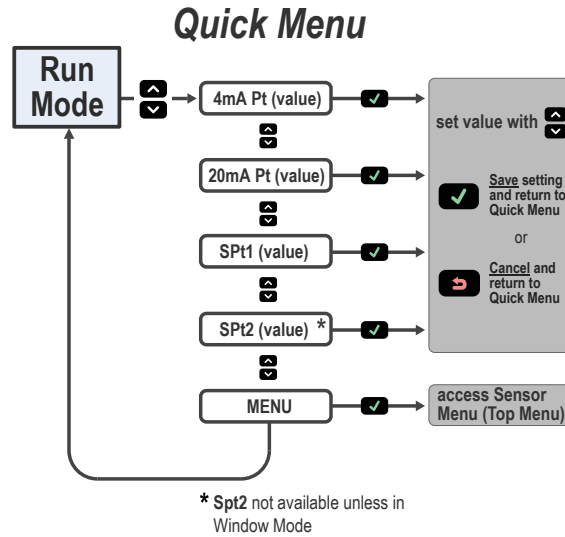



Figure 13. Quick Menu Map (Window Mode)

## Sensor Menu (MENU)

Access the Sensor Menu by pressing Enter  from Run mode. The Sensor Menu is also accessible from the Quick Menu: navigate to MENU and press Enter . The Sensor Menu includes several submenus that provide access to view and change sensor settings and to view sensor information.

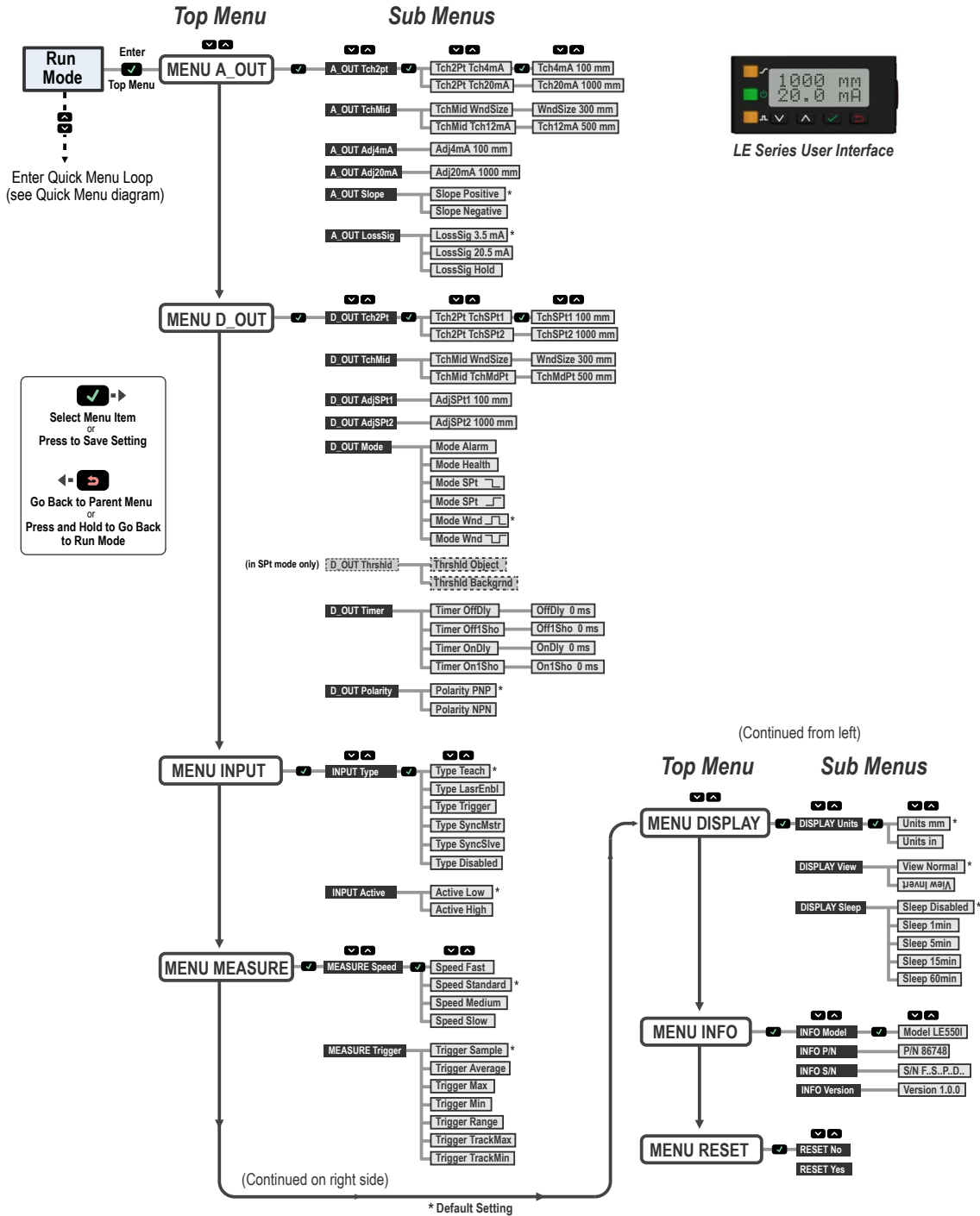

Figure 14. LE550 Sensor Menu Map (Analog Models)

## Specifications

**Supply Voltage (Vcc)**  
12 to 30 V dc

**Power and Current Consumption, exclusive of load**  
Normal Run Mode: 1.7 W, Current consumption < 70 mA at 24 V dc

**Supply Protection Circuitry**  
Protected against reverse polarity and transient overvoltages

**Output Configuration**  
Analog output: 4 to 20 mA or 0 to 10 V, depending on model  
Discrete output rating: Discrete NPN/PNP is user-configurable

**Output Ratings**  
Discrete Output: 100 mA maximum (protected against continuous overload and short circuit)  
OFF-state leakage current—PNP: < 10 µA at 30 V  
OFF-state leakage current—NPN: < 200 µA at 30 V  
Output saturation voltage—PNP outputs: < 3 V at 100 mA  
Output saturation voltage—NPN outputs: < 1.6 V at 100 mA  
Analog current output (LE...I Models): 1 kΩ max. @ 24 V; max. load resistance = [(Vcc-4.5)/0.02 Ω]  
Analog voltage output (LE...U Models): 2.5 kΩ min. load resistance

**Remote Input**  
Allowable Input Voltage Range: 0 to Vcc  
Active Low (internal weak pullup—sinking current):  
· High State > 4.3 V at 740 µA max.  
· Low State < 1.3 V at 800 µA max.  
Active High (internal weak pulldown—sourcing current):  
· High State > 4.3 V at 1.7 mA max.  
· Low State < 1.3 V at 1.6 mA max.

**Analog Resolution**  
LE250: 100 mm to 250 mm: Less than 0.02 mm  
LE250: 250 mm to 400 mm: Less than 0.2 mm  
LE550: 100 mm to 600 mm: Less than 0.5 mm  
LE550: 600 mm to 1000 mm: Less than 1 mm

**Analog Linearity**  
LE250: Linearity is the less of Accuracy or 0.3% of full scale range (± 0.9 mm) at any given distance  
LE550: Linearity is the lesser of Accuracy or 0.5% of full scale range (± 4.5 mm) at any given distance

**Typical Beam Spot Size<sup>1</sup>**

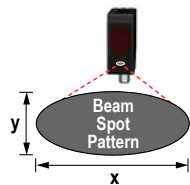

	Distance (mm)					
	LE250 Models			LE550 Models		
	100	250	400	100	550	1000
x	3.2	2.1	1.2	8.4	10.5	12.1
y	2.2	1.5	0.9	3.5	4.2	4.9

**Sensing Beam**  
Class 2 laser models: visible red, 650 nm  
Class 1 laser models: visible red, 650 nm

**Sensing Range**  
LE250: 100 mm (3.94 in) to 400 mm (15.75 in)  
LE550: 100 mm (3.94 in) to 1000 mm (39.37 in)

**Delay at Power Up**  
2 s

**Measurement/Output Rate**  
Class 2 laser models: < 1 ms  
Class 1 laser models (fast): < 1 ms  
Class 1 laser models (std/med/slow): < 2 ms

**Ambient Light Immunity**  
Class 2 laser models: > 10,000 lux  
Class 1 laser models: > 5,000 lux

**Minimum Window Size, Analog and Discrete**  
LE250: 1 mm (0.039 in)  
LE550: 10 mm (0.39 in)

**Boresighting**  
LE250: 4 mm radius at 400 mm  
LE550: 1 cm radius at 1 m

**Maximum Torque**  
2 N·m (17.7 in-lbs)

**Repeatability**  
See *Performance Curves*

**Temperature Effect**  
See *Performance Curves*

**Accuracy**  
See *Performance Curves*

**Construction**  
Housing: die-cast zinc  
Window: acrylic

**Vibration/Mechanical Shock**  
All models meet Mil. Std. 202 G requirements method 201A.  
Also meets IEC 60947-5-2.

**Response Time**

	Class 1 Laser Models	Class 2 Laser Models
Fast <sup>2</sup>	2 ms	2 ms
Standard	10 ms	5 ms
Medium	30 ms	15 ms
Slow	100 ms	50 ms

<sup>1</sup> Beam spot size is calculated as 1.6 times the D4σ measured value

<sup>2</sup> Response time for lateral entry of object into measurement range < 5 ms

Environmental Rating  
IEC IP67, NEMA 6

Operating Conditions

Temperature: -20 °C to +55 °C (-4 °F to +131°F)  
Humidity: 90% at +55 °C maximum relative humidity (non-condensing)

Storage Temperature

-30 °C to +65 °C (-22 °F to +149 °F)

Application Note

For optimum performance, allow 10 minutes for the sensor to warm up

Certifications



UL Environmental Rating: Type 1

Required Overcurrent Protection



**WARNING:** Electrical connections must be made by qualified personnel in accordance with local and national electrical codes and regulations.

Overcurrent protection is required to be provided by end product application per the supplied table. Overcurrent protection may be provided with external fusing or via Current Limiting, Class 2 Power Supply. Supply wiring leads < 24 AWG shall not be spliced. For additional product support, go to <http://www.bannerengineering.com>.

Supply Wiring (AWG)	Required Overcurrent Protection (Amps)
20	5.0
22	3.0
24	2.0
26	1.0
28	0.8
30	0.5

## Performance Curves

LE250 Models

LE550 Models

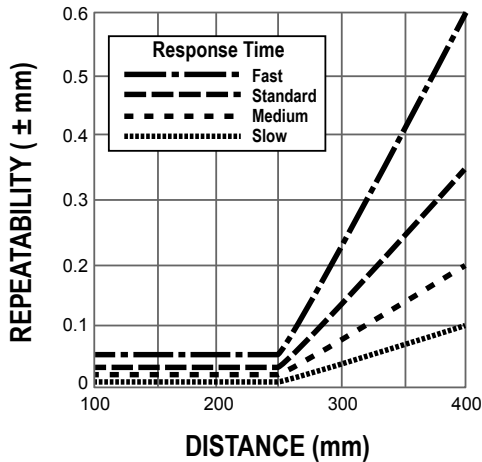

Figure 15. Repeatability (90% to 6% reflectance)

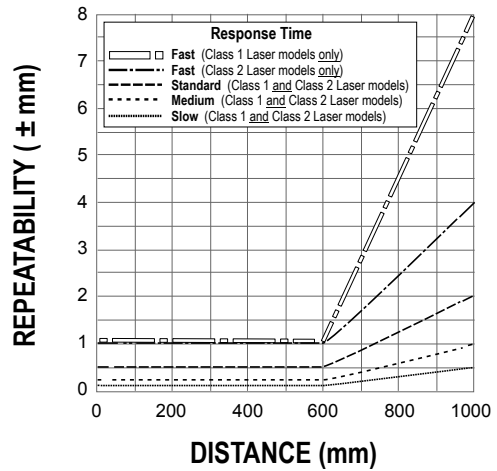

Figure 16. Repeatability (90% to 6% reflectance)